

# Magnetic Workholding

Improving process efficiency and precision accuracy

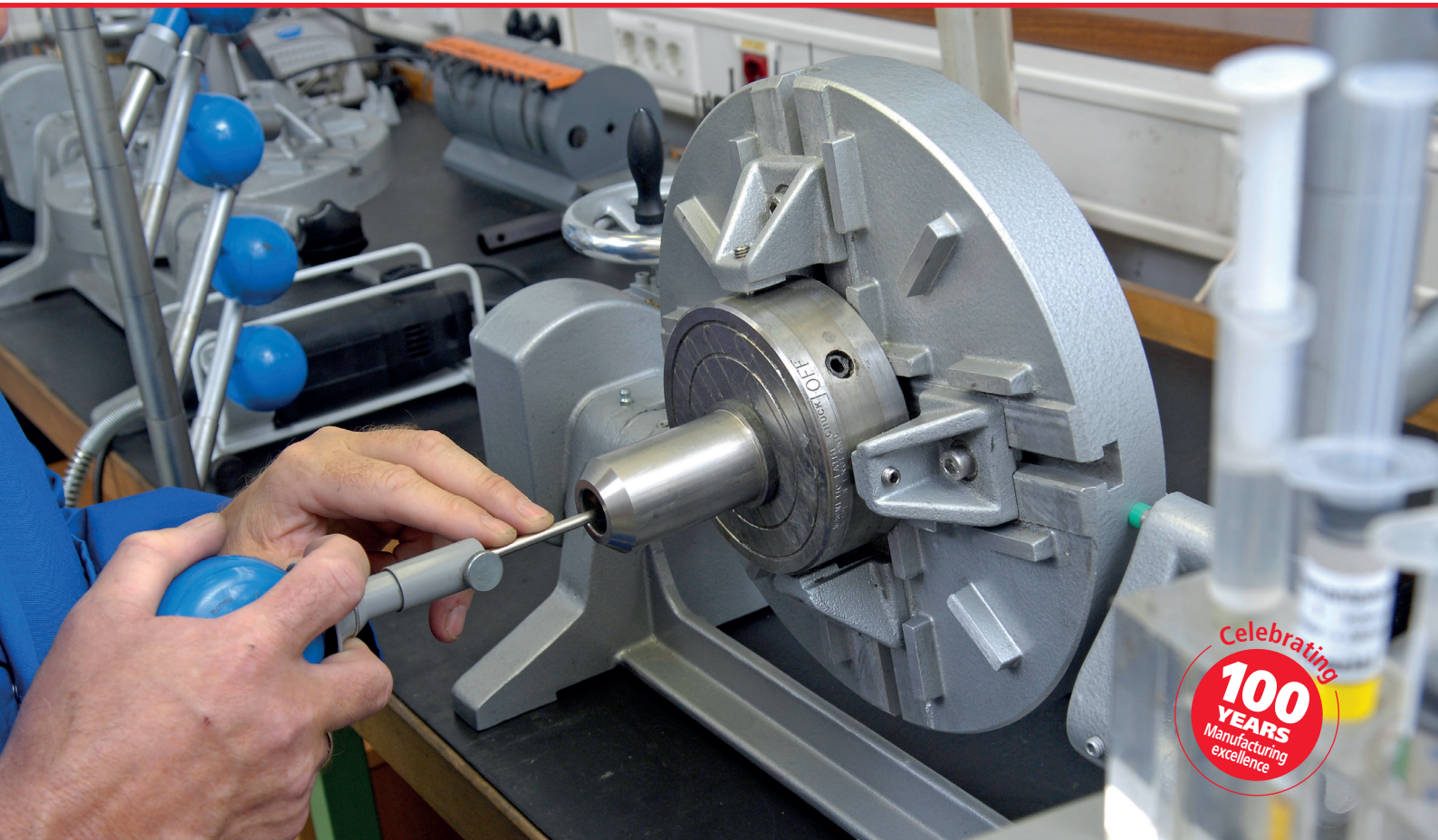

Celebrating  
**100**  
YEARS  
Manufacturing  
excellence

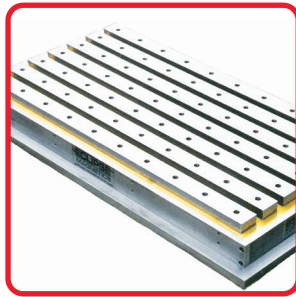



When precision counts,  
**Eclipse delivers...**



# Eclipse Magnetics

100 years of manufacturing excellence



Serving some of the leading names in industry

**Toyota**

**Honda**

**NSK**

**Denso**

**BMW**

**BAE Systems**

**JCB**

**TATA Steels**

**Ford**

## **A world leader in magnetic technology**

With 100 years of experience in the design and manufacture of high performance magnetic systems, we supply critical equipment to some of the leading names in the most demanding industries. Our magnetic technology is widely used at leading worldwide companies and in major development projects, all requiring a guarantee of equipment performance.

## **Designing excellence**

We have a track record of producing high quality products backed by a commitment to total customer service. Our technical application teams have a wealth of experience, thus ensuring many of our products are market leading innovations. All manufacturing is carried out under an ISO 9001 certified quality management system.

## **Unrivalled product range**

We serve worldwide markets with an extensive product range including workholding systems, filtration systems, foreign body removal systems, magnet assemblies and complex magnetic industrial equipment used in industries such as automotive, aerospace and nuclear. Many of our products are unique and are covered by global patents.

## **Worldwide support**

We offer worldwide support through our offices in the UK, Canada and China. We also have numerous employees in various territories and a network of technically trained partners to provide local product support.

# Driving competitive edge into precision operations

## High Performance Magnetic Workholding Systems





**How a machined part is held is as important as how it is cut.....**

An efficient manufacturing process requires good machine selection, premier cutting tools, good quality clean fluids and dependable workholding. The first three areas often receive substantial consideration and investment, but the workholding solution is often neglected.



With manufacturing operations using higher cutting speeds that place greater force on workholding equipment, choosing the correct workholding method is essential.

Eclipse Magnetics manufacture high performance magnetic workholding systems for a range of machining applications, from low volume single piece to high volume multi-part operations. Specifying an Eclipse system provides a range of advantages for your process:-

### Vast improvements in production efficiency

-  **Faster set up, feed rates and metal removal – can give 500% increase in units per hour**
-  **Clamping time reduced to virtually zero – instant location, no manual clamping**
-  **Continuous machining of 5 faces - no need to stop and relocate the workpiece**
-  **Easy access for through machining, cutting and drilling**
-  **Improved safety – failsafe permanent magnetic technology guarantees a secure hold**

### Guaranteed precision

-  **100% consistent clamping – no operator variations**
-  **Eliminates vibration – extends tool life and improves accuracy**
-  **Ideal for multi-part and multi-directional machining**







# 100% Accuracy: Repeatability

One of the biggest challenges for precision manufacturers is to produce a consistent quality product. Repeated accuracy requires perfect holding integrity.

Using permanent magnetic technology, Eclipse Magnetics workholding systems generate a consistent clamping force which drastically reduces the risk of part variations during machining.

# Give your business the edge.....

A few of our many satisfied customers...

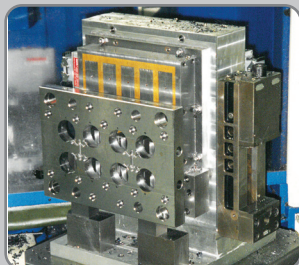

## **Mason Pinder** **Mould making**

### **Product: Supermill**

As specialists in precision design and manufacture of mould tools, accuracy is vital for Mason Pinder.

Magnetic workholding has become the norm on their machining processes, every time a new machine is commissioned a magnetic workholding system is also ordered. Supermill is used on horizontal machines with the chucks mounted on tombstones, the main benefit is that it gives access to machining 5 sides. The Supermill chucks currently in use include a 39" high x 24" wide x 78" long unit with 2 sides magnetic.

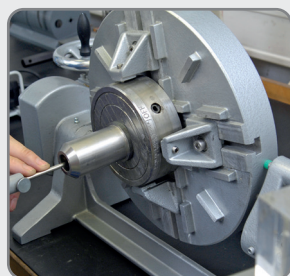

## **Novapax** **Precision mould making**

### **Product: Premier Range Circular**

Novapax are a leading mould maker for the plastics industry. Premier range magnetic chucks are used for holding grinding tools whilst they are being refurbished. It is vital that the tools are in premium condition to ensure that the moulds are produced to precise tolerances. The main advantage is that magnetic workholding does not damage the tooling during clamping. In addition downtime was reduced as mounting components can be done in just a few seconds. The concentric chuck eliminates any vibration thus ensuring an accurate repeatable grind.



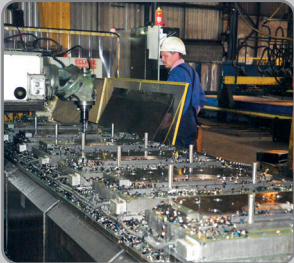
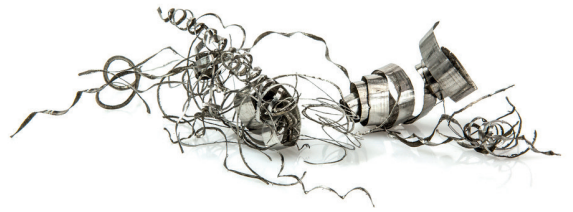

## **TATA Steels** **Steel plate machining**

### **Product: Supermill**

Tata are one of the world's largest steel producers. Supermill magnetic workholding has been key to reducing costs on the plate machining processes at 3 sites in the UK. The sites replaced manual clamping with magnetic systems. The access to 5 sides and faster clamping significantly improved process times. Subsequently magnetic systems have been used for weld preparation at the sites.

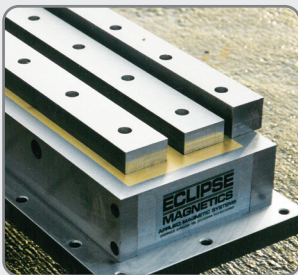

## **John Brown Engineering** **Sub-contract engineering**

### **Product: Supermill**

Magnetic workholding systems played a vital role in successfully completing a project to manufacture a new aircraft catapult launch rail for an aircraft carrier. During the assembly, clamping the main support bar was difficult as there were no straight sides or holes for mounting. Traditional clamping systems could not provide a reliable, uniform hold. Supermill solved the problem and ensured that the contract could be fulfilled.

# Optimum workholding solutions

## Important considerations

### Premier chucks

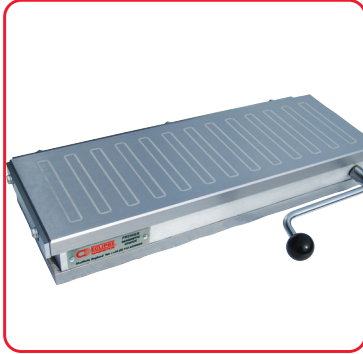

### Standard chucks

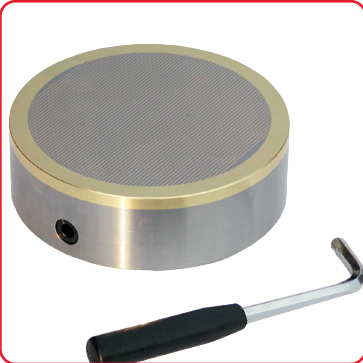

### Power Matrix



## Product Selector

A guide on how to use our standard products. Please speak to our sales

Product Type	Page	Applications			
		Turning	Grinding	Light Milling	Gen Heavy
<b>Rectangular Range (Manual Chucks)</b>					
Premier Range Rectangular Chucks	9		✓	✓	
Standard Range Standard Pole Rectangular Chucks	13		✓	✓	
Standard Range Fine Pole Rectangular Chucks	13		✓		
<b>Circular Range (Manual Chucks)</b>					
Premier Radial Pole Circular Chucks	12	✓	✓	✓	
Premier Straight Pole Circular Chucks	11	✓	✓	✓	
Standard Range Standard Pole Circular Chucks	14	✓	✓	✓	
Standard Range Fine Pole Circular Chucks	14	✓	✓	✓	
Magnetic Sine Tables	15		✓		
<b>Electro-magnetic Chucks</b>					
Supermill	17			✓	

Note: Table is an approximate guide for specific applications please contact us.

## Important Key factors to consider

A guidance on key considerations when choosing the correct product. Please contact our sales department for more information or for any specific requirements.

## Material Thickness

To achieve maximum clamping force minimum materials should be observed.

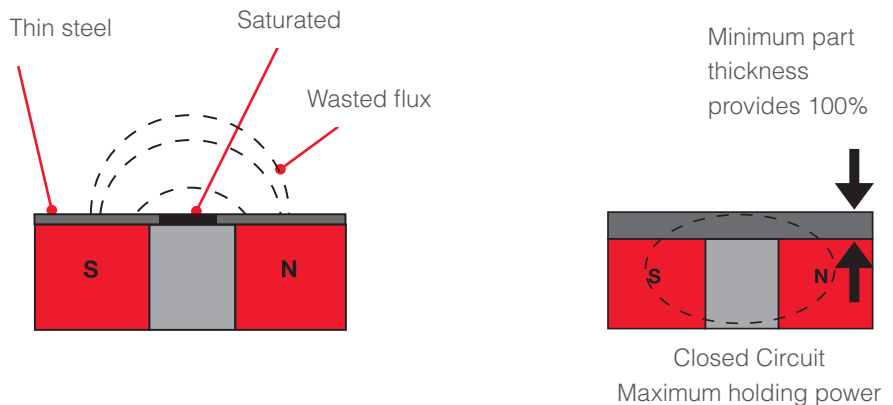





department for more information.

General / milling	Material Thickness (mm)					
	1	2	5	10	15	20 and above
			✓	✓	✓	✓
		✓	✓	✓	✓	✓
	✓	✓	✓	✓	✓	✓
				✓	✓	✓
			✓	✓	✓	✓
		✓	✓	✓	✓	✓
	✓	✓	✓	✓	✓	✓
	✓	✓	✓	✓	✓	✓
✓					✓	✓

## Material Type

The scale below highlights the effect that material type has on clamping forces.

## Workpiece Material

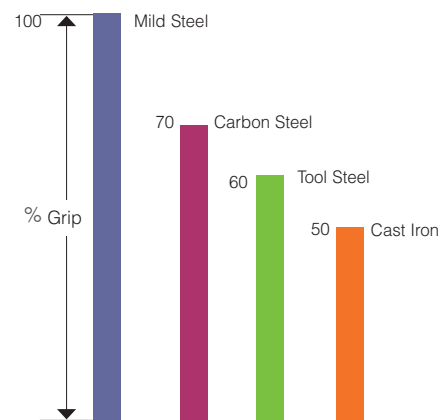

## Air Gaps

An air gap between the magnet and the load will also affect lifter performance. The chart below shows the general effect on different materials.

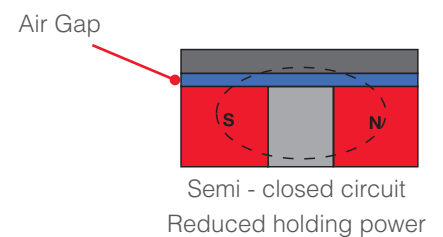
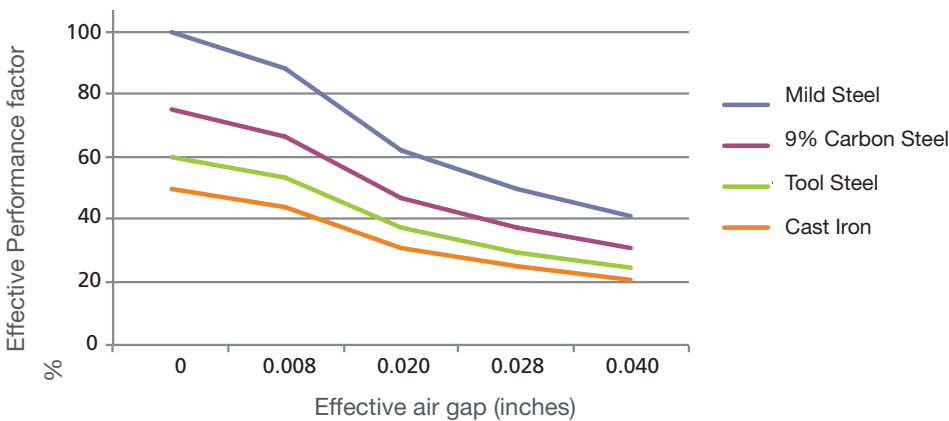

As the air gap increases the magnetic performance reduces.

# Premier Rectangular Chuck

Eclipse Magnetics invented the world's first permanent magnetic chuck in 1934 and we continue to set the benchmark for quality workholding with the Premier Range.

Guaranteed to retain their magnetism, the premier chucks are manufactured from high performance materials providing optimum holding power and efficient use of the workholding area.

## Robust chrome plated side and end stops

For location on product and for fencing in the smaller parts.

## Extended base plate

For fixing the chuck to the machine bed with the clamps supplied. (Tee nuts not included).



## Technical Data

Product number	Dimensions inches			
	Length	Height	Width	Pole pitch
AX47/P	8.0	1.7	5.0	0.7
AX510/P	10.9	2.1	5.1	1.4
AXS612/P	12.7	2.5	5.9	1.3
AXS614/P	14.2	2.5	5.9	1.3
AXS618/P	17.8	2.5	5.9	1.3
AXM824/P	23.7	2.5	7.9	1.4

## How it works

The chuck is switched on and it is in pitch with the top plate when it is out of pitch with the workpiece.

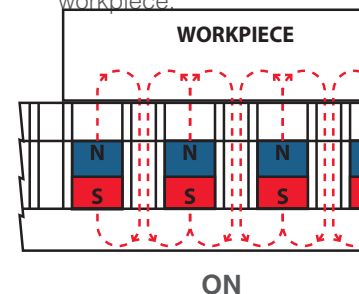





### Additional top plates

These chucks offer additional top plates.

These plates can be mounted on the top of the original and can be fully machined to provide location or nesting of parts.

These are generally used as fixtures where they are changed for different components.

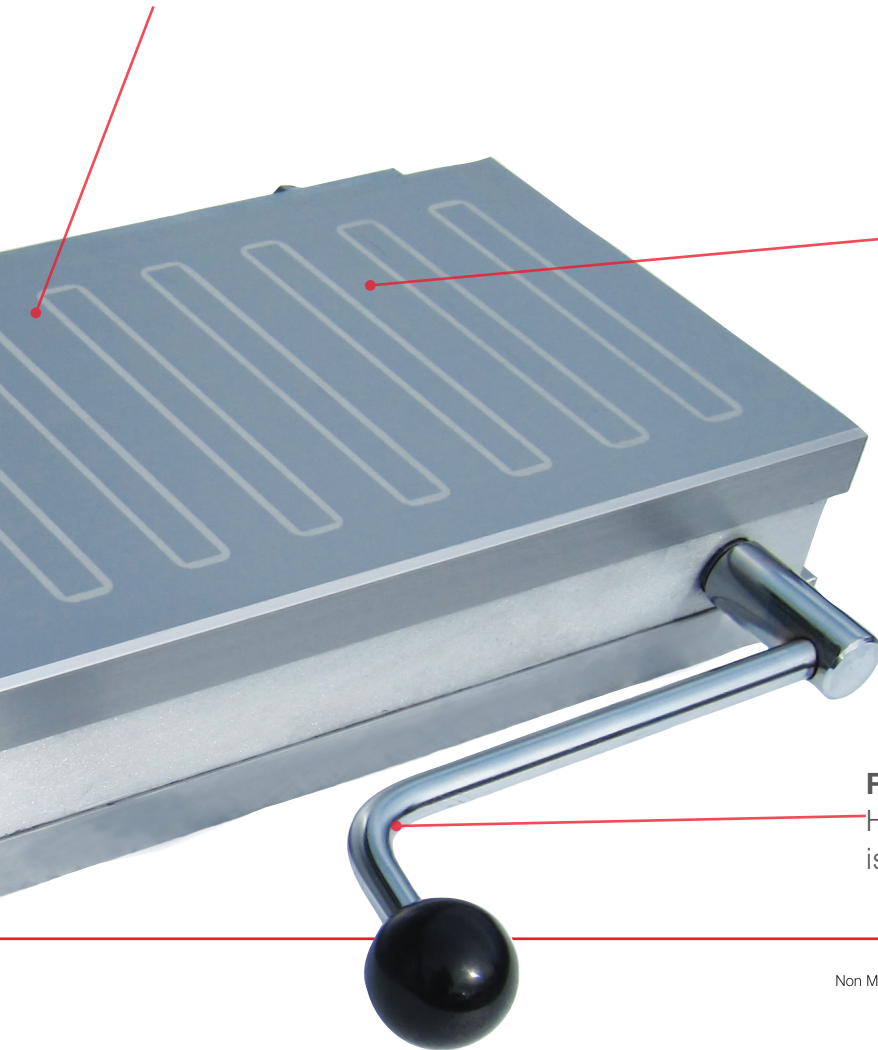

### Thick all metal top plate

- This is a one piece section with steel inserts.
- Inserts are fixed with white metal.
- Provides high accuracy and ample life for multiple regrinds.
- Allows the top plate to be machined and drilled for location on large production runs.\*

\* Please consult manufacturer for positioning.

### Removable ergonomic operating handle

Handle can be removed once required power is achieved.

and off by moving the central magnet pack **A**. When the **B** magnetism is directed into the workpiece, the top plate magnetism is directed away from the

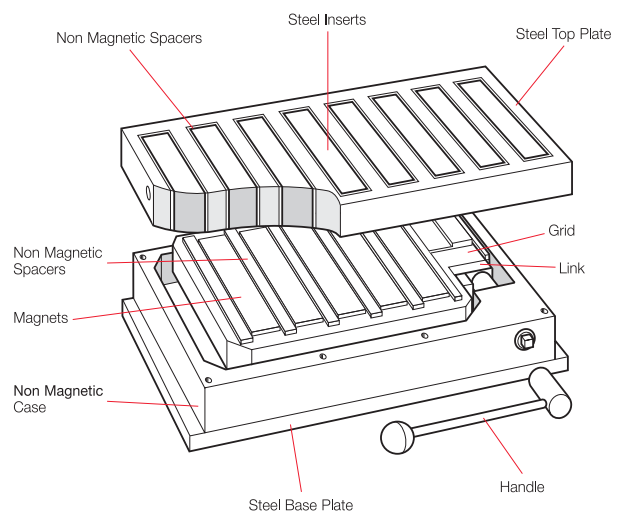
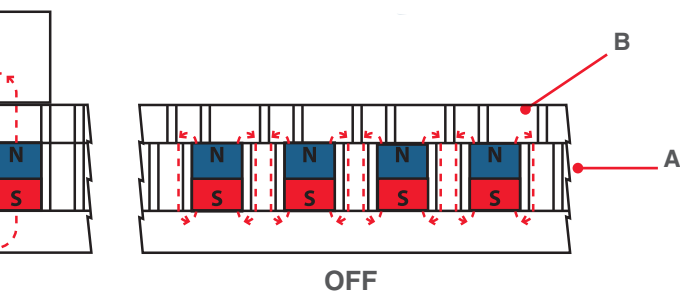

# Premier Circular Chuck Range

## Premier Circular Chuck

Ideal for a wide range of applications including inspection, grinding and turning.

Ideal for materials from 0.118" thick upwards and disc materials.

## Concentric guide rings

The parallel pole version is manufactured with concentric rings machined into the front face to act as a positional guide for the part prior to clocking.

## All metal top plate

- This is a one piece section with steel inserts
- Inserts are fixed with white metal.
- Provides high accuracy and longer life for multiple regrinds.
- Allows the top plate to be machined and drilled for location on large production runs

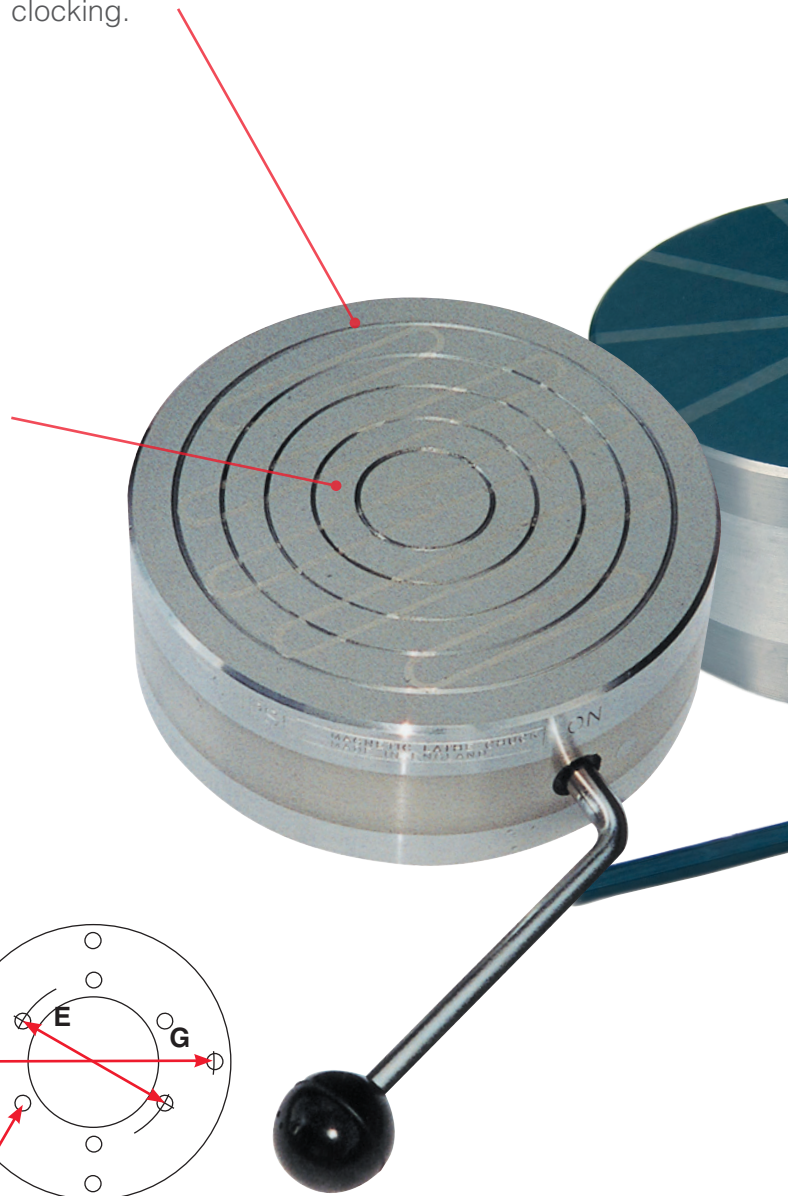

## Technical Data

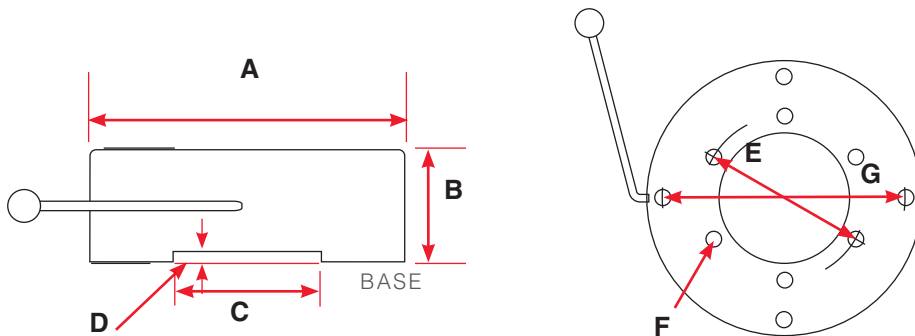

Product number	Dimensions inches						
	A*	B	C	D	PCD1 E	F	PCD 2 G
AX475C/P	4.8	1.8	2.0	0.3	3.0	M6	4.0
AX651C/P	6.6	2.4	3.0	0.3	4.0	M10	5.5
AX91C/P	9.0	2.4	3.4	0.3	4.5	M10	7.5
AX12C/P	12.0	2.8	6.0	0.2	7.3	M12	10.0

\*Reference diameter only

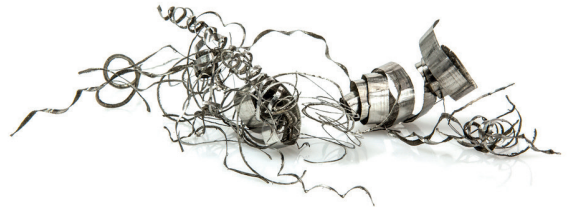

### Variable hold on both parallel and radial pole versions

(Operating handle can be stopped in any position)  
Provides option of partial (variable) hold essential for clocking the work concentrically prior to switching to full power.

### Premier Radial Pole Chuck

Ideal for a wide range of precision grinding and medium/heavy turning applications, the radial pole is the best option for ring type applications such as inspection and precision grinding.

The radial pole is the best option for heavy turning on ring type components.

The design concentrates the entire magnetism from the chuck to the point in contact with the workpiece, ensuring excellent hold.

The workpiece on this type of chuck should not cover more than 50% of the pole area.

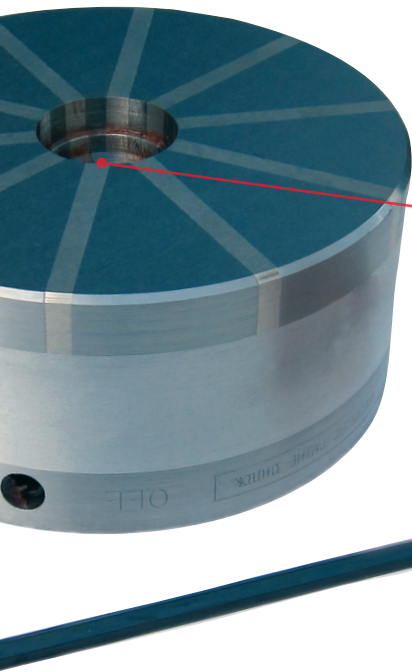

### Through bore

All sizes of the radial pole chucks from the 150mm diameter and above are supplied complete with a through bore.

A blanking plug is available for when the bore is not required.\*

The bore is ideal for through spindle coolant applications.

\* N/A for NR100C.

### Radial Pole is radially balanced

While the switching principle is the same on all of the premier range the radial pole version uses a round magnet pack that rotates to switch. This ensures that the chucks stay in balance when rotating and can be spun up to a maximum of 3000rpm.

### Technical Data

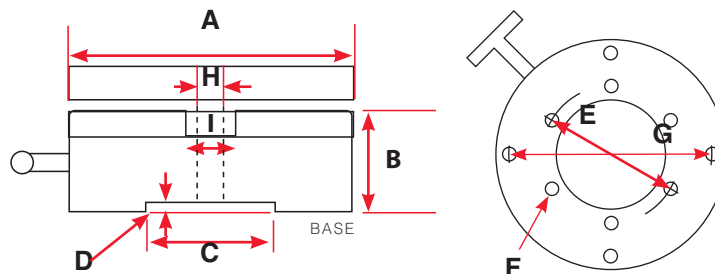

Product number	Dimensions inches									Number of Poles
	A*	B	C	D	PCD1		PCD2		I	
NR100C	3.9	1.9	0.08	0.3	n/a	M6	3.0	n/a	n/a	6
NR150C	5.9	2.7	0.12	0.2	n/a	M10	4.0	1.3	1.4	10
NR225C	8.9	2.8	0.13	0.2	4.5	M10	7.5	2.0	2.1	14
NR300C	11.8	2.8	0.24	0.2	7.2	M12	10.0	2.4	2.6	18



# Standard Chuck Range

Available in a choice of 2 pole formats.

Both options are manufactured with steel and brass laminations and integral high performance neodymium magnets in the top plate to enhance the performance.

## Top plate

Rectangular chucks have full width active top plate

## Robust chrome plated side and end stops

For location on product and fencing in the smaller parts.

## Base plate

Recessed ends for fixing the chuck to the machine bed with the clamps supplied. (Tee nuts not included).



## Technical Data

### Rectangular

Product number		Dimensions inches		
		A	B	C
STD POLE	FINE POLE			
	ERFP1018	7.1	3.9	2.0
	ERFP1530	11.8	5.9	2.0
	ERFP1535	13.8	5.9	2.0

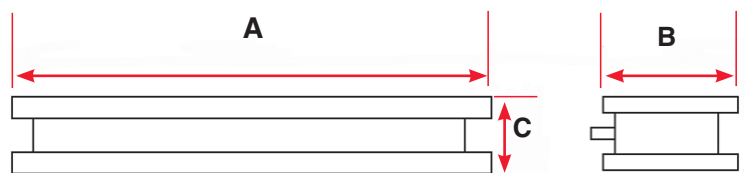



## Standard chucks are available with a choice of 2 pole spacings:



### Fine Pole

0.060" steel / 0.020" brass, ideal for thin and small work pieces less than 0.118" thick down to 0.027".



### Standard Pole

0.157" steel / 0.079" brass, effectively clamping all work pieces above 0.118" thick

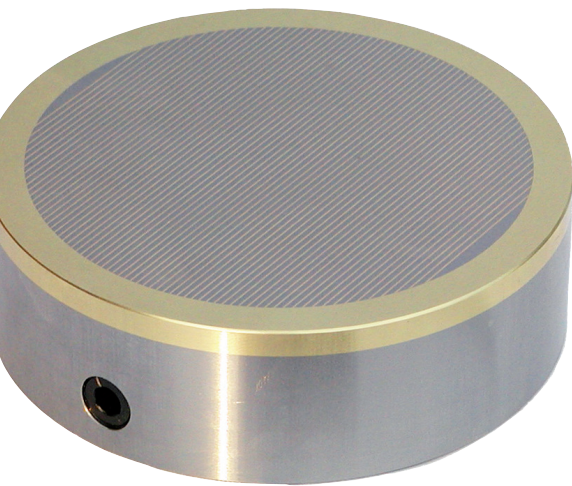

Fine pole

### Performance

Both variants produce 80N/cm<sup>2</sup> clamping force.

### Fixing details

Rear drilled and tapped holes with datum locator.

### Removable ergonomic operating handle

Handle can be removed once the required power is achieved.

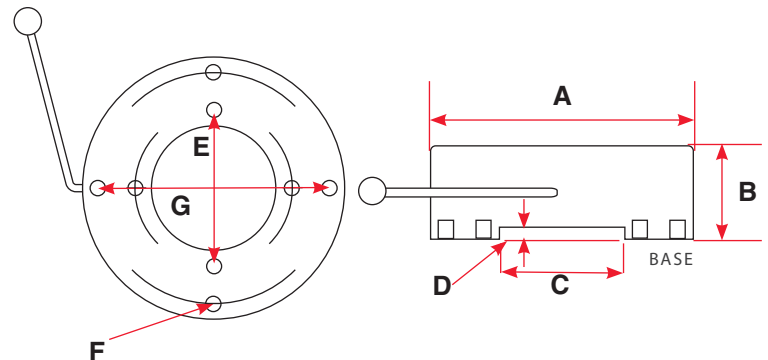
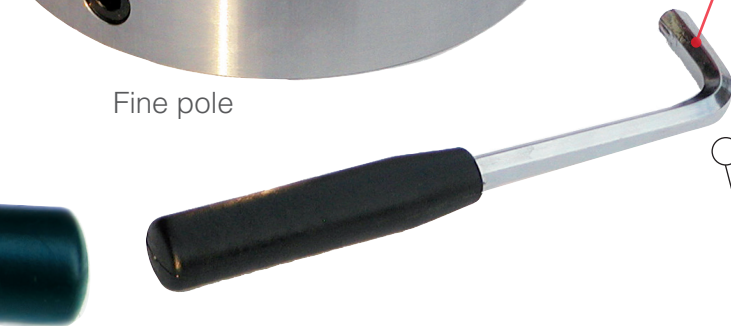

## Technical Data

Circular

Product number	FINE POLE	Dimensions inches						
		A	B	C	D	PCD E	F	PCD G
ECSP100	ECFP100	3.9	2.0	2.0	0.3	3.0	M6	n/a
ECSP125	ECFP125	4.9	2.0	2.0	0.3	3.0	M6	4.0
	ECFP160	6.2	2.0	3.0	0.3	4.0	M10	5.5
ECSP255	ECFP255	10.0	2.0	3.4	0.3	4.5	M10	7.5

# Workholding Accessories

## Simple magnetic sine tables (short lift)

- Accuracy of sine table within (+/- 5 secs of arc)
- Pole spacing 0.078" (0.060" Steel 0.020" Brass)
- Sine table calculations included
- Clamping force 80N/cm<sup>2</sup>
- Incorporates neodymium magnets



## Technical Data

Product number	Top Plate		Base		Height at Zero	Unit Weight lbs
	Length	Width	Length	Width		
SSTFP1018	7.1	3.9	8.5	4.5	2.9	22.0
SSTFP1325	10.0	5.1	11.6	7.7	3.1	45.2
SSTFP1535	13.8	5.9	15.4	6.5	3.5	79.4

## Chuck blocks

Chuck blocks can be used for a number of reasons:

- Transfer magnetism from the top plate of the chuck through to the workpiece.
- Support irregular workpieces
- Acts to make the top face of the blocks finer pole for thinner workpieces
- Provides a magnetic side support for taller products

Can be used horizontally or vertically.

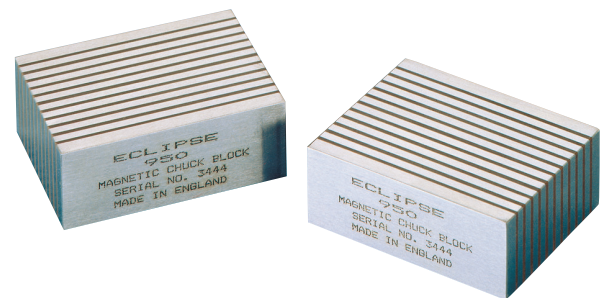

## Technical Data

Product number	Length	Width	Height	Pole direction
950	2.4	3.0	1.2	longitudinal*
950V	2.0	3.9	1.6	longitudinal*

\*Along width

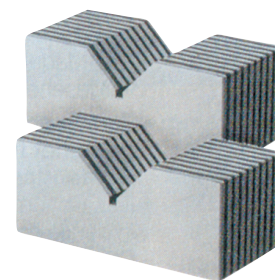

Supplied in matched and numbered



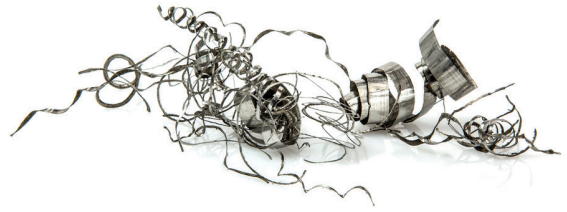

## 'V' blocks

'V' blocks are ideal for holding cylindrical and complex workpieces for marking, spark erosion, grinding and measurement operations.

Can be used on its base, side or end.

## Technical Data

Product number	Width	Length	Height	Max. dia. of workpiece		Unit Weight
				Top 'V'	Bottom 'V'	
inches						
<b>25 Micron Accuracy</b>						
E934	2.8	4.0	3.8	2.3	0.9	4.4
E934MP	2.8	4.0	3.8	2.3	0.9	8.7
E935	2.8	3.1	3.8	2.3	0.9	6.9
E935MP	2.8	3.1	3.8	2.3	0.9	13.8
<b>10 Micron Accuracy</b>						
E933A	2.8	4.7	3.7	2.3	0.9	9.7
E933MPA	2.8	4.7	3.7	2.3	0.9	19.4
E935A	2.8	3.1	3.7	2.3	0.9	6.5
E935MPA	2.8	3.1	3.7	2.3	0.9	13.0

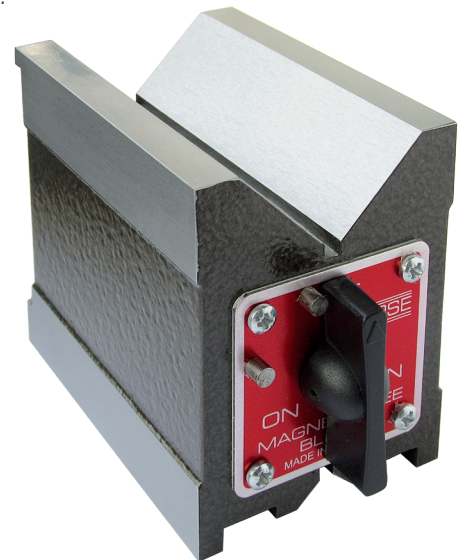

MP and MPA= Matched Pair

## Table top demagnetiser

This is a lightweight unit for the removal of residual magnetism following grinding. Some materials will retain magnetism following long periods of magnetic clamping. The more alloys in the material the more magnetism will be retained.

- Operation is simple, the part is simply drawn across the top plate.
- We supply the unit in 2 different voltages, it is important to select the correct voltage for your installation.

## Technical Data

Product number	Voltage	Width	Height	Depth	Unit Weight
	v				
DB956CAN	110	5.9	4.6	3.4	8.4

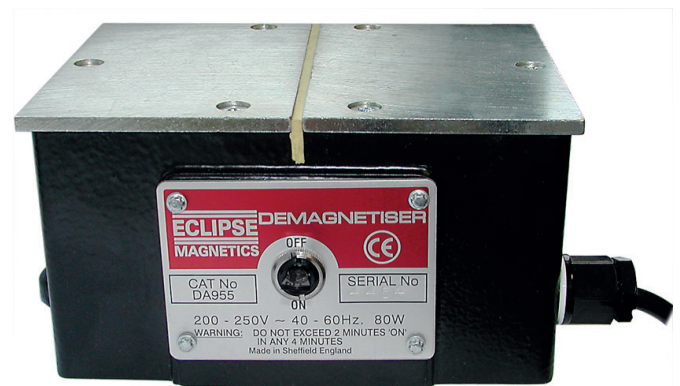

# Supermill

The ultimate permanent electro-magnetic chuck

The Supermill heavy duty chuck is the ultimate in workholding, outperforming traditional clamping systems and other milling chucks.

- Provides an instantaneous 100 tonnes m<sup>2</sup> of clamping force
- Failsafe permanent magnetic technology – maintains hold even if power is cut
- Maximises feed rates
- Uniform clamping, no vibration
- Push button, remote control
- 5 side access to workpiece

## Ease of tooling

- As the poles are long parallel strips the tooling is simple.
- Bars can be cut to any length and simply screwed to the base poles to transfer the magnetism into the workpiece.
- This allows the ability to protect the chuck surface and allow through drilling and machining to take place without the risk of damaging the chuck.

## Robust build quality

- Milling chuck must be robust to withstand the test of time.
- Many chucks rely on a single central M6 or M8 to provide the structure of the magnet pole.
- The parallel pole design of the Supermill allows for multiple fixings to be made on each pole ensuring the internal rigidity of the chuck.

## Component accessibility

- Provides access to machine all 5 sides of the component in a single operation reduces machining time and improving thereby reducing efficiency.
- Reduced vibration also increases, efficiency by allowing faster feed rates, improved finish and longer tool life.

## Parallel pole technology

The parallel pole design ensures maximum clamping force and allows multiple fixtures to be made on each pole.

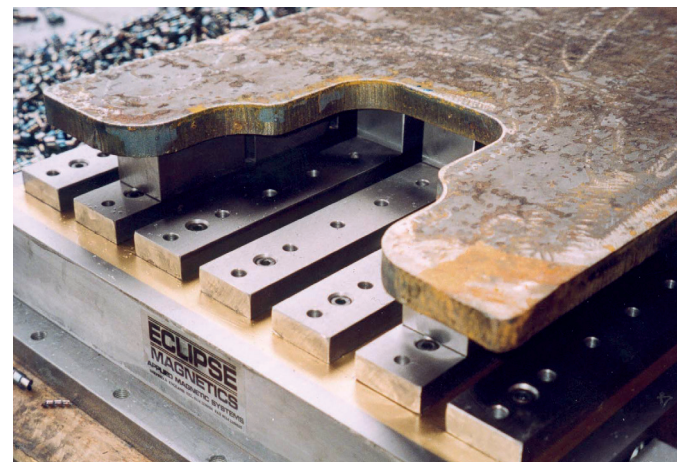
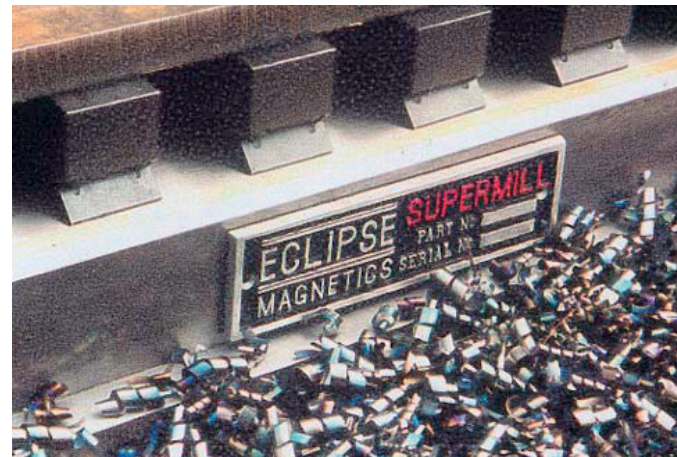

## How it works

A pulse of power changes the polarity of the base magnet into and out of the workpiece when switching on and

**ON**

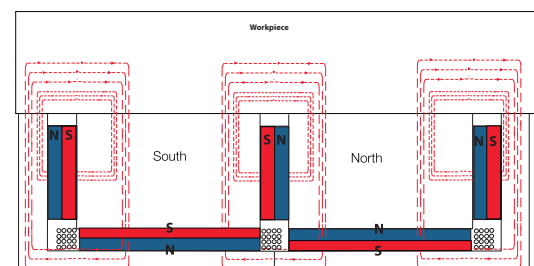





## Continuous machining

Supermill can be supplied with pole extensions this allows through drilling and machining without damaging the surface of the chuck.

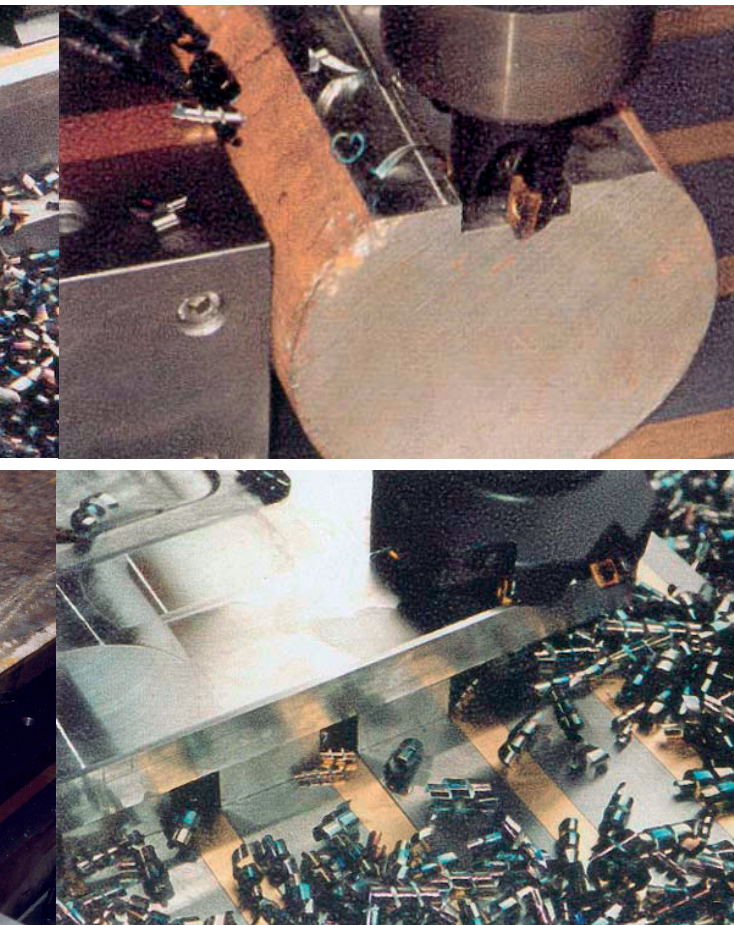

## Technical Data

Product number	Length	Width	Thickness	Weight
	inches	inches	inches	lbs
SM4525	17.7	9.8	3.7	196.2
SM4532	17.7	12.6	3.7	242.5
SM4539	17.7	15.6	3.7	291.0
SM4546	17.7	18.1	3.7	337.3
SM6325	24.8	9.8	3.7	242.5
SM6332	24.8	12.6	3.7	308.6
SM6339	24.8	15.4	3.7	363.8
SM6346	24.8	18.1	3.7	421.1
SM6353	24.8	20.9	3.7	458.0
SM6360	24.8	23.6	3.7	542.3
SM8125	32.1	9.8	3.7	463.0
SM8132	32.1	12.6	3.7	520.3
SM8139	32.1	15.4	3.7	577.6
SM8146	32.1	18.1	3.7	634.9
SM8153	32.1	20.9	3.7	694.5
SM8160	32.1	23.6	3.7	751.8
SM10025	39.4	9.8	3.7	414.5
SM10032	39.4	12.6	3.7	524.7
SM10039	39.4	15.4	3.7	632.7
SM10046	39.4	18.1	3.7	740.8
SM10053	39.4	20.9	3.7	848.8

The 6001 controller is used on all of the Supermill, and larger installations of the ESPM range of products.

The controller offers single/double channels, dependent upon the chip used.

Operation of the 6001 controllers can be made in the following ways:

- A remote-control pendant
- Via the machine, PLC.

magnet, this directs the magnetic field off.

OFF

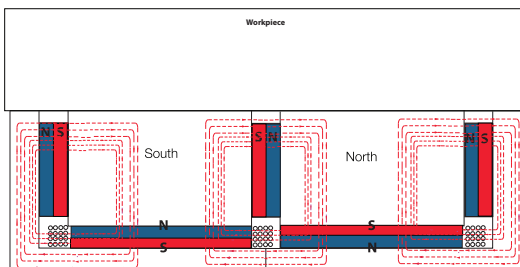

The controller is used for the on/off operation of the Supermill

## Controllers

Product number	Height	Width	Depth	Voltage
	inches	inches	inches	v
6001CONT460V	13.4	16.0	6.0	460

\*Requires 6001 MH Hand Pendant



# Other Products

In addition to our workholding range, Eclipse Magnetics manufacture a wide range of high performance magnetic products for diverse applications.



Sub-micron filtration for industrial fluids



Lifting and handling systems



Magnetic aids for workshop & general engineering applications



Magnetic materials & assemblies



Foreign body removal - separation systems



Heating system filters

# Eclipse Magnetics Worldwide

## Americas

442 Millen Road, Unit 9,  
Stoney Creek  
Ontario, L8E 6H2,  
Canada

**T** +1 905 664 5585  
**F** +1 905 664 7090  
sales@eclipsetoolsinc.com

## Europe

Atlas Way  
Sheffield  
S4 7QQ  
England

**T** +44 (0)114 225 0600  
**F** +44 (0)114 225 0610  
info@eclipsemagnetics.com

## China

No. 168 Chengjian Road  
Minhang District  
Shanghai  
PR China

**T** +86 21 6434 8600 \*150  
**F** +86 21 6434 6488  
szhou@eclipsemagnetics.com

Representative:

[www.eclipsemagnetics.com/en-us](http://www.eclipsemagnetics.com/en-us)

### Eclipse Tools North America Inc.

442 Millen Road Unit 9, Stoney Creek, ON L8E 6H2  
**T** 1-800-260-2124 **F** 1-800-260-1410  
sales@eclipsetoolsinc.com [www.eclipsemagnetics.com/en-us](http://www.eclipsemagnetics.com/en-us)



While every effort has been made to ensure the accuracy of the information in this publication please note that specifications may change without notice.



v3



Innovative Magnetic Solutions

